

SINGLE LINE DIAGRAM OF 132KV GRID SUBSTATION, AEGCL, DULLAVCHERRA

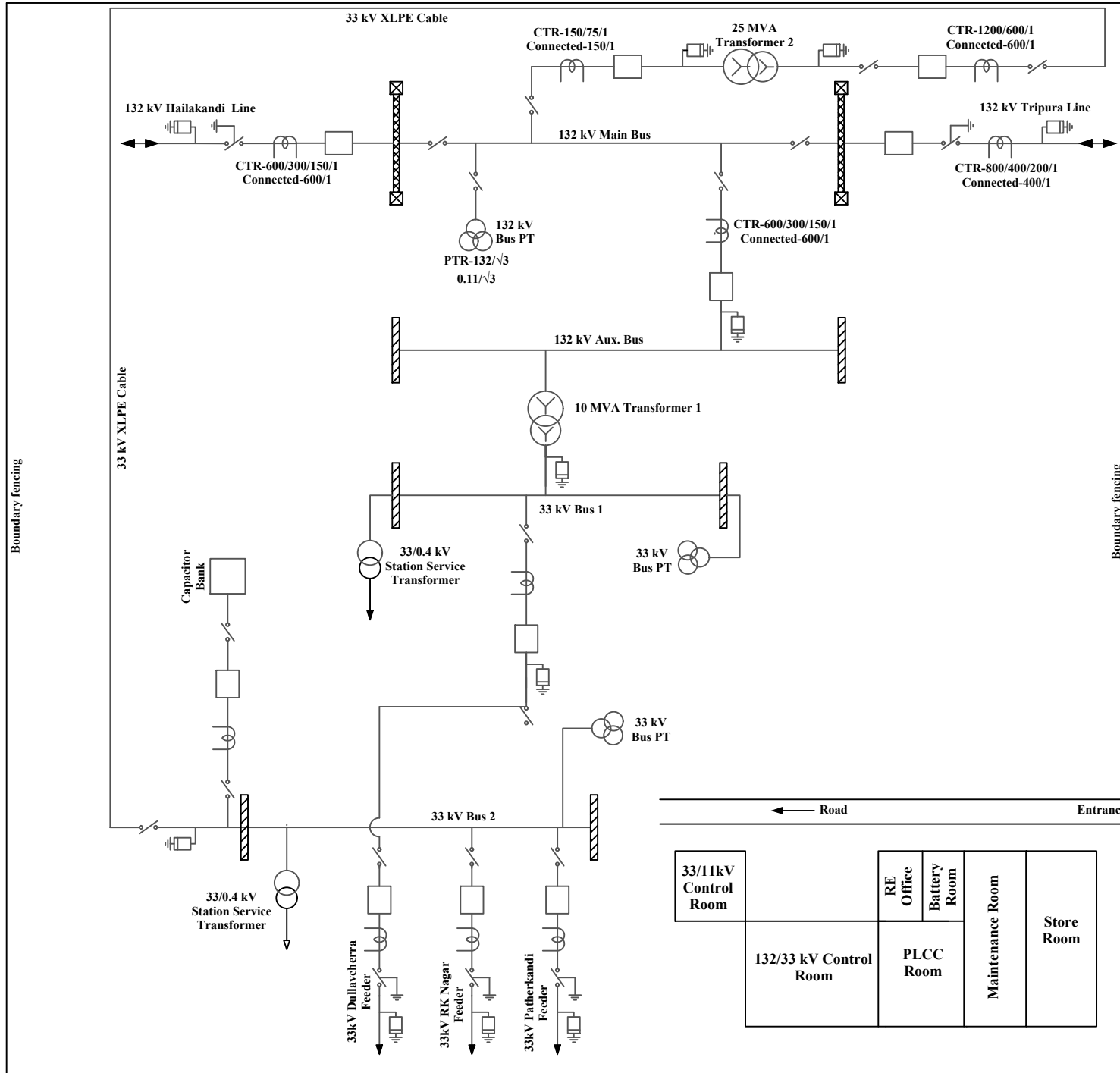







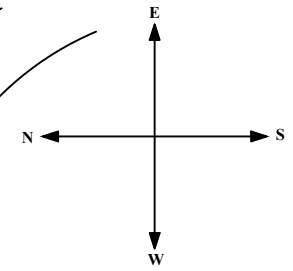
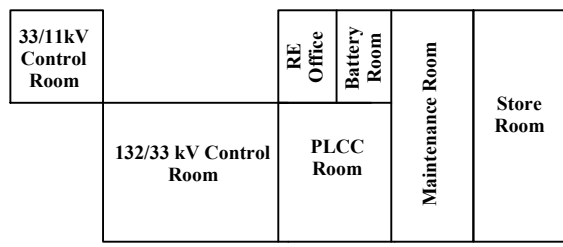

Boundary fencing

Boundary fencing

Road

Entrance



EXISTING LEGENDS	
	Circuit Breaker
	Isolator
	Isolator with Earthswitch
	Lightning Arrestor
	Transformer
	Potential Transformer
	Current Transformer

Assam Electricity Grid Corporation Limited	
Single Line Diagram of 132/33 kV Dullavcherra Grid Sub-Station	